

# 300mA Dual Voltage Regulator IC Monolithic IC MM3348

June, 2008

## Outline

This IC is a 300mA-output low-saturation type Dual regulator developed as a combined power supply for cell-phones.

The output voltages of the regulator can be fixed to desired voltages in a 1.2 V to 5.0 V range.

The device is further provided with a switching terminal for each output, making it an IC especially suitable for cell-phones.

## Features

- |                                   |  |
|-----------------------------------|--|
| 1. Maximum output current         | 300mA max.   |
| 2. Ripple rejection               | 70dB (1kHz, I <sub>OUT</sub> =30mA)                        |
| 3. Output voltage accuracy        | V <sub>o1</sub> , V <sub>o2</sub> : ±2%                    |
| 4. No load input current          | V <sub>o1</sub> : 45µA typ.<br>V <sub>o2</sub> : 45µA typ. |
| 5. Input voltage                  | 6V max.  |
| 6. Output ON/OFF control function | High : ON    Low : OFF                                     |

## Package

HSOP-8A

## Applications

1. Mobile phones
2. Portable players
3. Digital still cameras
4. Mobile game machines
5. PDAs

Block Diagram

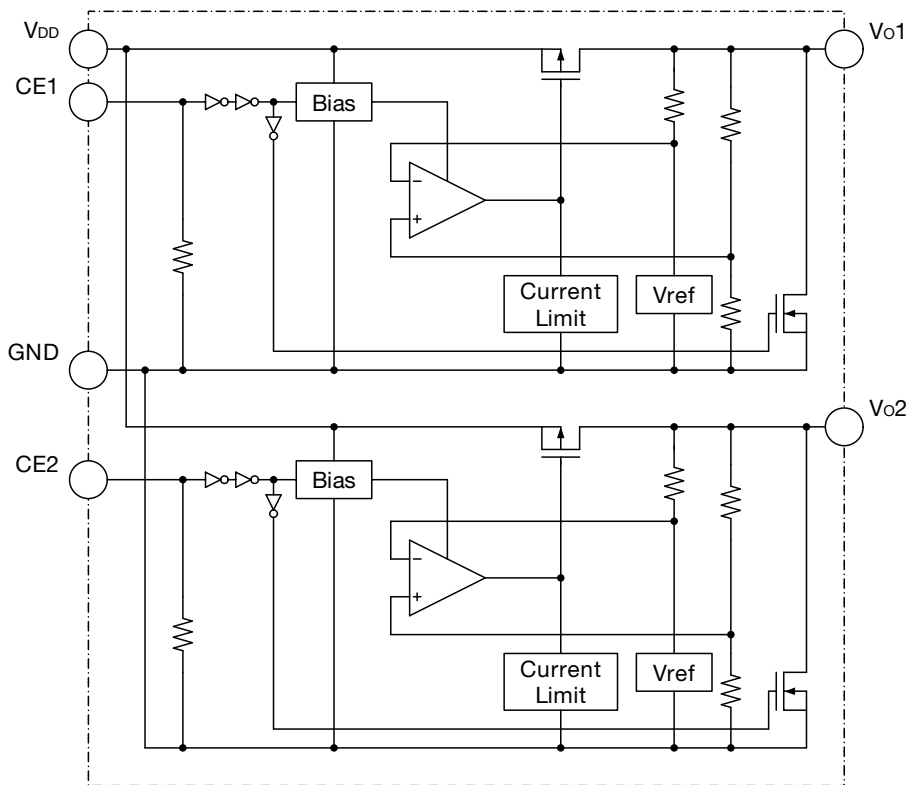

Pin Assignment

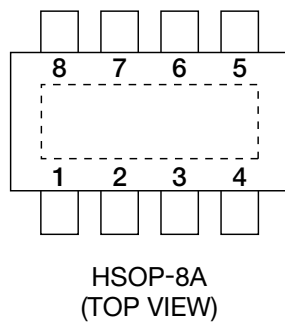

1	NC
2	CE1
3	GND
4	Vo1
5	Vo2
6	GND
7	CE2
8	V <sub>DD</sub>

## Pin Description

Pin No.	Pin name	Functions	Internal equivalent circuit						
1	NC	No connection							
2,7	CE1, CE2	ON/OFF-CONTROL 1, 2PIN <table border="1" style="margin-left: 20px;"> <tr> <td>CE</td> <td>OUTPUT</td> </tr> <tr> <td>Low</td> <td>OFF</td> </tr> <tr> <td>High</td> <td>ON</td> </tr> </table> Connect CE pin with VDD pin, when it is not used.	CE	OUTPUT	Low	OFF	High	ON	Please refer to Block diagram.
CE	OUTPUT								
Low	OFF								
High	ON								
3,6	GND	GND Pin							
4,5	Vo1,Vo2	Output 1, 2 pin							
8	VDD	Voltage-supply pin							

## Absolute Maximum Ratings (Except where noted otherwise Ta=25°C)

Item	Symbol	Ratings	Units
Storage Temperature	T <sub>STG</sub>	-55~+150	°C
Supply Voltage	V <sub>DD</sub>	6.5	V
CE1, 2 input Voltage	V <sub>CE1, 2</sub>	-0.3~V <sub>DD</sub> +0.3	V
Output Voltage 1, 2	V <sub>O1, 2</sub>	-0.3~V <sub>DD</sub> +0.3	V
Output Current 1, 2	I <sub>O1, 2max.</sub>	350	mA
Power Dissipation	P <sub>d</sub>	1800(Note1)	mW

Note1 : With the double sided PC Board of glass epoxy. (37×37×1.6mm copper plane 80%)

## Recommended Operating Conditions (Except where noted otherwise Ta=25°C)

Item	Symbol	Ratings	Units
Operating Ambient temperature	T <sub>JOP</sub>	-40~85	°C
Operating Voltage	V <sub>OP</sub>	2~6	V
Output Current 1, 2	I <sub>O1, 2</sub>	0~300	mA

## Electrical Characteristics 1 (Except where noted otherwise V<sub>DD</sub>=V<sub>O</sub> (typ.)+1V, V<sub>CE</sub>=V<sub>DD</sub>, Ta=25°C)

Item	Symbol	Measurement conditions	Min.	Typ.	Max.	Units
Input Current (OFF)	I <sub>DDoff1</sub>	V <sub>CE1</sub> =V <sub>CE2</sub> =0V		0.1	2.0	μA
<b>Voltage Regulator 1</b>						
No-load Input Current 1	I <sub>DD1</sub>	V <sub>CE1</sub> =V <sub>DD</sub> , V <sub>CE2</sub> =0V I <sub>O1</sub> =0mA		45	70	μA
Output Voltage 1	V <sub>O1</sub>	1mA ≤ I <sub>O1</sub> ≤ 30mA	×0.98		×1.02	V
Line Regulation 1	V <sub>LINE1</sub>	V <sub>DD</sub> =V <sub>O1</sub> (typ.)+0.5-6V, I <sub>O1</sub> =30mA (V <sub>O1</sub> ≤ 1.6V, V <sub>DD</sub> =2.2-6V)		0.02	0.10	%/V
Load Regulation 1	V <sub>LOAD1</sub>	1mA ≤ I <sub>OUT</sub> ≤ 300mA		50	120	mV
Dropout Voltage 1	V <sub>IO1</sub>	Please refer to another page				V

Item	Symbol	Measurement conditions	Min.	Typ.	Max.	Units
Ripple Rejection 1-1 (Note2)	RR1-1	f=1kHz, Vripple=0.5V, Io1=30mA (Vo1≤1.7V, VDD=Vo1+1.2V)		70		dB
Ripple Rejection 1-2 (Note2)	RR1-2	f=10kHz, Vripple=0.5V, Io1=30mA (Vo1≤1.7V, VDD=Vo1+1.2V)		60		dB
Vo1 Temperature Coefficient (Note2)	$\Delta V_{o1} / \Delta T$	Io1=30mA -40≤Top≤85°C		±100		ppm/°C
Output Noise Voltage 1 (Note2)	Vn1	fBW=10~100kHz		30		μVrms
Output Short-Circuit Current 1 (Note2)	Ilim1	Vo1=0V		40		mA
CE1 Pull-down Resistance	Rpd1		0.7	2	8	MΩ
CE1 High Threshold Voltage	VCE1H		1.5		VDD	V
CE1 Low Threshold Voltage	VCE1L		0		0.3	V
Output NMOS ON Resistance 1	RDON1	VCE1=0V VDD=4V(Vo1<3V)		60		Ω
<b>Voltage Regulator 2</b>						
No-load Input Current 2	IDD2	VCE2=VDD, VCE1=0V Io1=0mA		45	70	μA
Output Voltage 2	Vo2	1mA≤Io2≤30mA	×0.98		×1.02	V
Line Regulation 2	VLINE2	VDD=Vo2(typ.)+0.5~6V, Io2=30mA (Vo2≤1.6V, VDD=2.2~6V)		0.02	0.10	%/V
Load Regulation 2	VLOAD2	1mA≤Io2≤300mA		50	120	mV
Dropout Voltage 2	Vio2	Please refer to another page				V
Ripple Rejection 2-1 (Note2)	RR2-1	f=1kHz, Vripple=0.5V, Io2=30mA (Vo2≤1.7V, VDD=Vo2+1.2V)		70		dB
Ripple Rejection 2-2 (Note2)	RR2-2	f=10kHz, Vripple=0.5V, Io2=30mA (Vo2≤1.7V, VDD=Vo2+1.2V)		60		dB
Vo2 Temperature Coefficient (Note2)	$\Delta V_{o2} / \Delta T$	Io2=30mA -40≤Top≤85°C		±100		ppm/°C
Output Noise Voltage 2 (Note2)	Vn2	fBW=10~100kHz		30		μVrms
Output Short-Circuit Current 2 (Note2)	Ilim2	Vo2=0V		40		mA
CE2 Pull-down Resistance	Rpd2		0.7	2	8	MΩ
CE2 High Threshold Voltage	VCE2H		1.5		VDD	V
CE2 Low Threshold Voltage	VCE2L		0		0.3	V
Output NMOS ON Resistance 2	RDON2	VCE1=0V VDD=4V(Vo2<3V)		60		Ω

Note2 : The item is guaranteed by design.

**Electrical Characteristics 2** (Except where noted otherwise  $V_{DD}=V_O$  (typ.)+1V,  $V_{CE}=V_{DD}$ ,  $T_a=25^\circ\text{C}$ )

Output Voltage $V_{O1}, V_{O2}$	Item							
	Output Voltage 1, 2				Dropout Voltage 1, 2			
	$V_{O1}, V_{O2}$ (V)				$V_{IO1}, V_{IO2}$ (V)			
	Measurement Conditions	Min.	Typ.	Max.	Measurement Conditions	Min.	Typ.	Max.
1.2V	1mA ≤ I <sub>O</sub> ≤ 30mA	1.170	1.200	1.230	(Note3)			
1.3V		1.270	1.300	1.330				
1.4V		1.370	1.400	1.430				
1.5V		1.470	1.500	1.530	I <sub>O</sub> =150mA		0.38	0.70
1.6V		1.568	1.600	1.632			0.36	0.65
1.7V		1.666	1.700	1.734			0.34	0.60
1.8V		1.764	1.800	1.836	1.8V ≤ V <sub>O</sub> ≤ 2.0V I <sub>O</sub> =150mA		0.32	0.55
1.9V		1.862	1.900	1.938				
2.0V		1.960	2.000	2.040				
2.1V		2.058	2.100	2.142	2.1V ≤ V <sub>O</sub> ≤ 2.7V I <sub>O</sub> =150mA		0.28	0.50
2.2V		2.156	2.200	2.244				
2.3V		2.254	2.300	2.346				
2.4V		2.352	2.400	2.448				
2.5V		2.450	2.500	2.550				
2.6V		2.548	2.600	2.652				
2.7V		2.646	2.700	2.754				
2.8V		2.744	2.800	2.856	2.5V ≤ V <sub>O</sub> ≤ 5.0V I <sub>O</sub> =150mA		0.22	0.35
2.9V		2.842	2.900	2.958				
3.0V		2.940	3.000	3.060				
3.1V		3.038	3.100	3.162				
3.2V		3.136	3.200	3.264				
3.3V		3.234	3.300	3.366				
3.4V		3.332	3.400	3.468				
3.5V		3.430	3.500	3.570				
3.6V		3.528	3.600	3.672				
3.7V		3.626	3.700	3.774				
3.8V		3.724	3.800	3.876				
3.9V		3.822	3.900	3.978				
4.0V		3.920	4.000	4.080				
4.1V		4.018	4.100	4.182				
4.2V	4.116	4.200	4.284					
4.3V	4.214	4.300	4.386					
4.4V	4.312	4.400	4.488					
4.5V	4.410	4.500	4.590					
4.6V	4.508	4.600	4.692					
4.7V	4.606	4.700	4.794					
4.8V	4.704	4.800	4.896					
4.9V	4.802	4.900	4.998					
5.0V	4.900	5.000	5.100					

Note3 : The parameter is not guaranteed in the model less than  $V_O=1.4V$ .

## Measuring Circuit

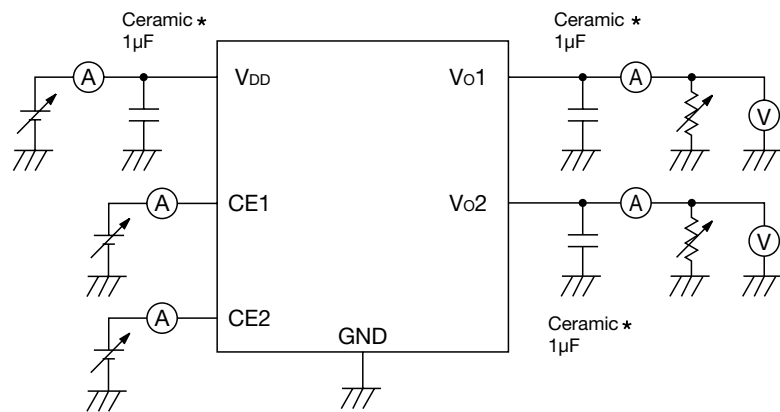

## Application Circuit

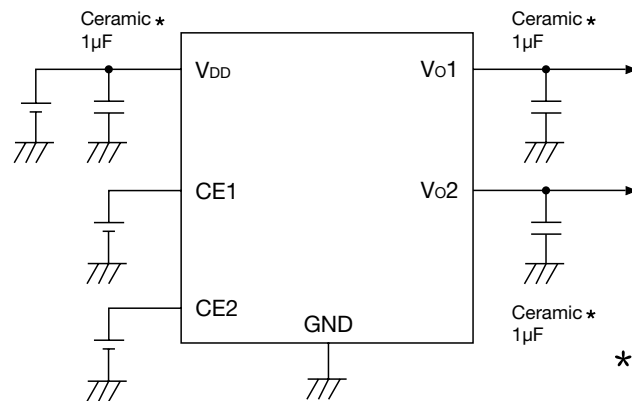

\* Temperature Characteristics : B

(reference example of external parts)

- Output capacitor                      Ceramic capacitor 1µF
- Input Capacitor                      Ceramic capacitor 1µF

· Note

1. The output capacitor is required between output and GND to prevent oscillation.
2. The ESR of capacitor must be defined in ESR stability area.

It is possible to use a ceramic capacitor without ESR resistance for output.

The ceramic capacitor must be used more than 1.0µF and B temperature characteristics.

3. The wire of Vcc and GND is required to print full ground plane for noise and stability.
4. The input capacitor must be connected a distance of less than 1cm from input pin.
5. In case the output voltage is above the input voltage, the overcurrent flow by internal parastic diode from output to input.

## About Power Dissipation

This IC's GND pin and Heat Spreader Bottom effectively radiate heat. By increasing these copper foil pattern area of PCB, Power dissipation improves. Please kindly design PCB pattern taking care of above features about power dissipation.

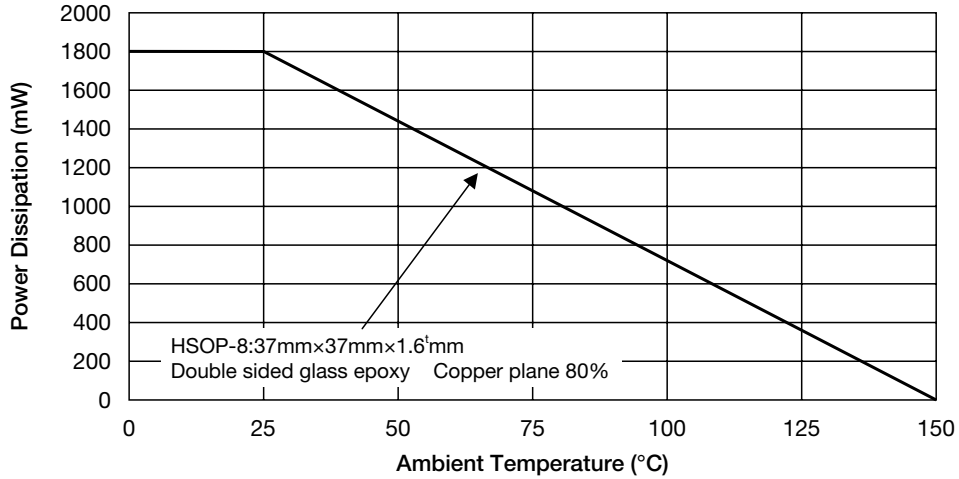

## Land Pattern Recommendation

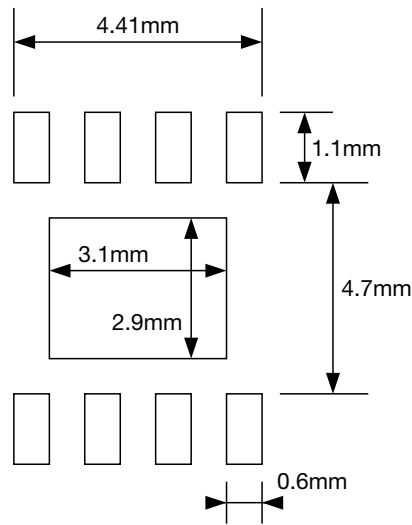

**Characteristics (Vo=1.2V)** (Except where noted otherwise V<sub>DD</sub>=V<sub>OUT</sub> (typ.) +1V, V<sub>CE</sub>=V<sub>DD</sub>, Ta=25°C)

**Output voltage - Input voltage**

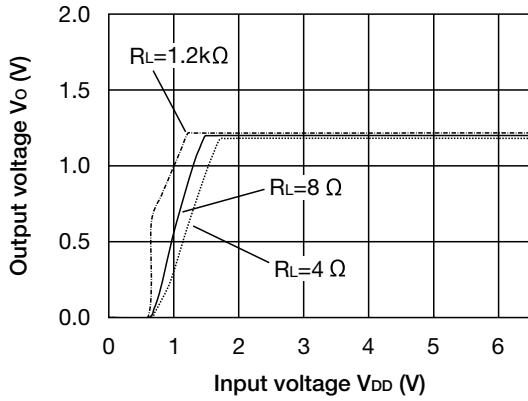

**Input current - Input voltage**

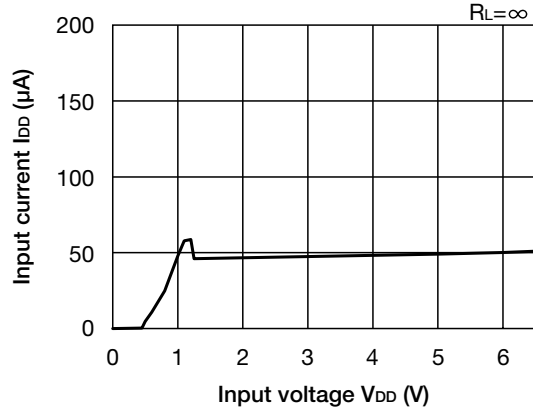

**Output voltage - Output current**

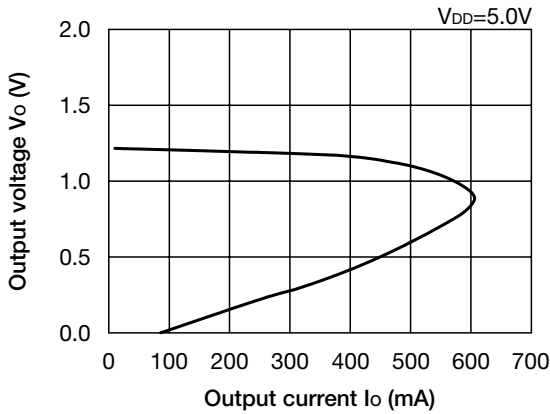

**Load regulation**

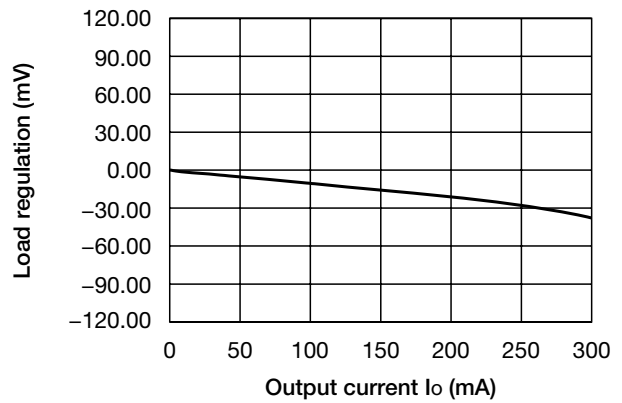

**Line regulation**

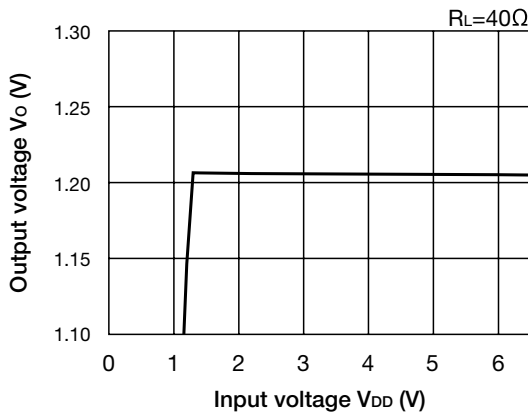

**Output voltage - Ambient temperature**

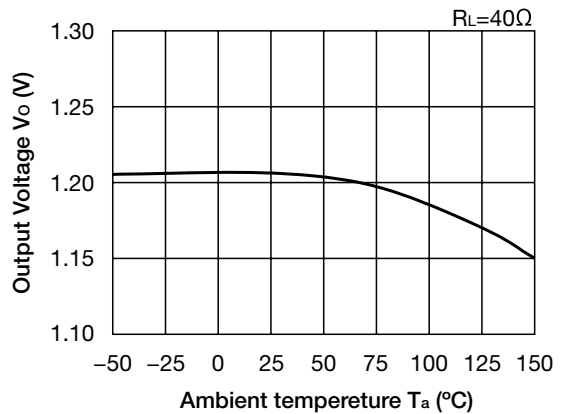

• Any products mentioned in this catalog are subject to any modification in their appearance and others for improvements without prior notification.  
 • The details listed here are not a guarantee of the individual products at the time of ordering. When using the products, you will be asked to check their specifications.



**Characteristics (Vo=3.3V)** (Except where noted otherwise V<sub>DD</sub>=V<sub>OUT</sub> (typ.) +1V, V<sub>CE</sub>=V<sub>DD</sub>, Ta=25°C)

**Output voltage - Input voltage**

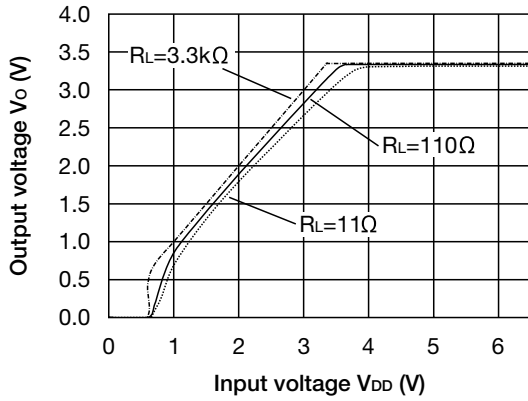

**Input current - Input voltage**

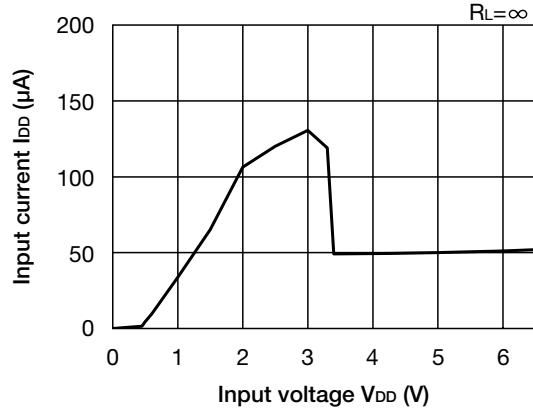

**Output voltage - Output current**

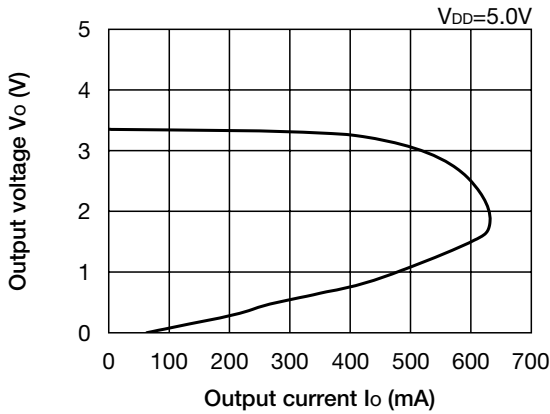

**Load regulation**

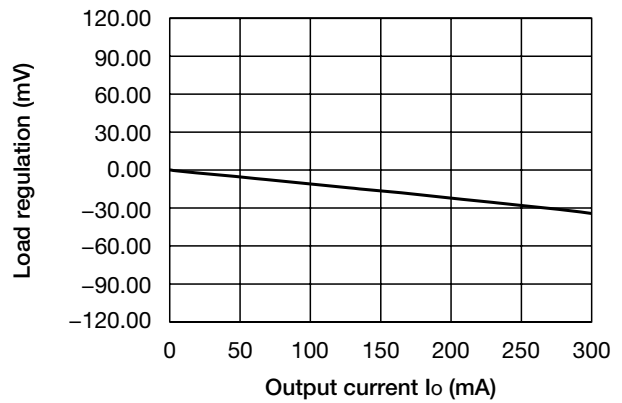

**Line regulation**

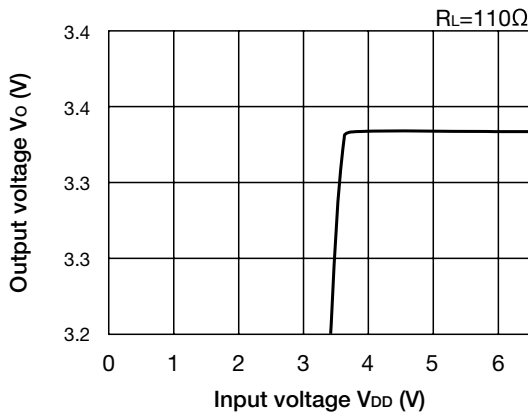

**Output voltage - Ambient temperature**

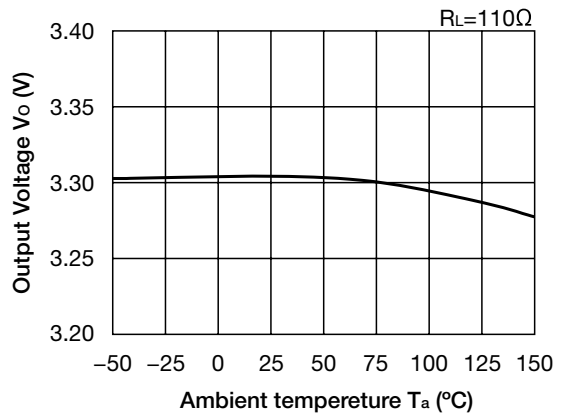

• Any products mentioned in this catalog are subject to any modification in their appearance and others for improvements without prior notification.  
 • The details listed here are not a guarantee of the individual products at the time of ordering. When using the products, you will be asked to check their specifications.

Dropout voltage

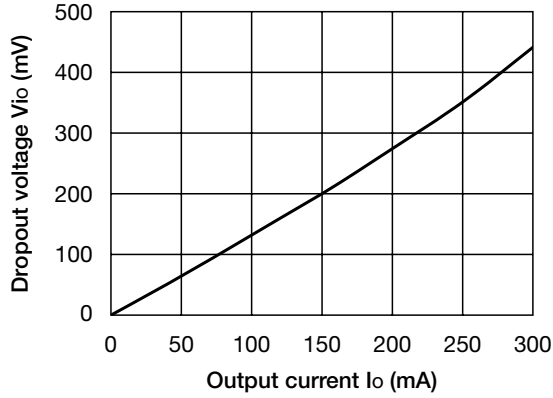

Ripple Rejection

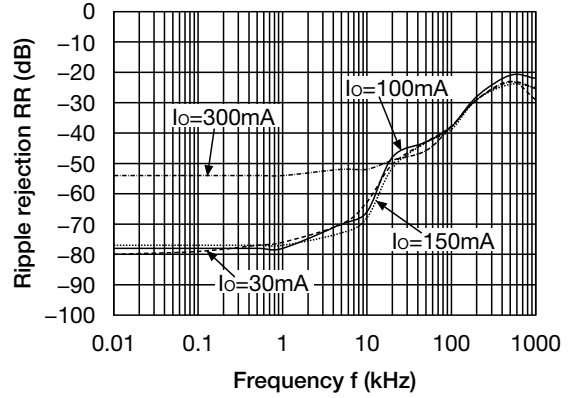

Load transient response ( $I_o=10 \rightarrow 100mA$ )

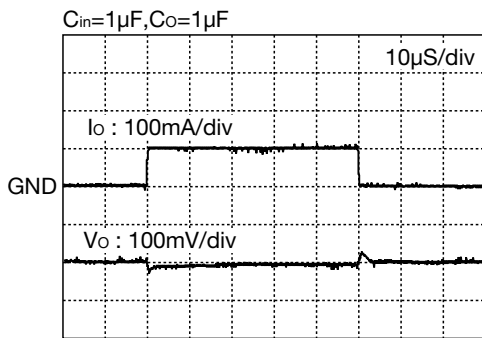

Load transient response ( $I_o=10 \rightarrow 200mA$ )

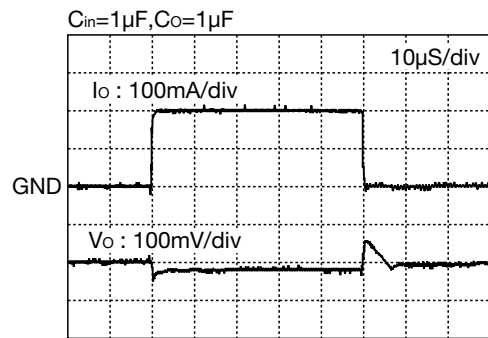

Load transient response ( $I_o=10 \rightarrow 300mA$ )

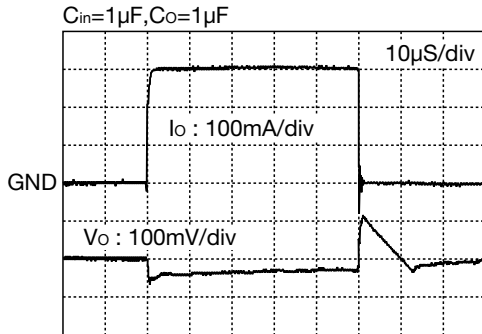

ESR stable area

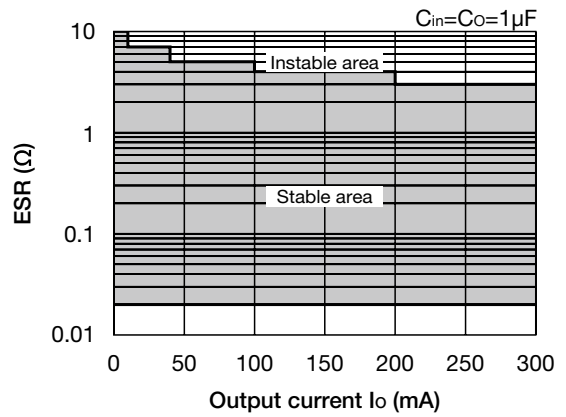

• Any products mentioned in this catalog are subject to any modification in their appearance and others for improvements without prior notification.  
 • The details listed here are not a guarantee of the individual products at the time of ordering. When using the products, you will be asked to check their specifications.